

PRODUCT DESCRIPTION

- Easy LED service (assembly and disassembly OPK-4 extrusion „on click”)
- Line of light in the built-in lighting fixture without visible aluminum elements
- Can build fixtures going seamlessly from built-in to suspended ones
- OPK-4 profile can be bent
- Smoothly changing lighting height
- Fits in the thickness of a drywall board (12mm)
- Lighting fixtures can be combined to form lighting strings (ZM connectors)
- The standard TPK-4 profile comes with a “foam technical cover” that facilitates “clean” mounting of the fixture in the drywall

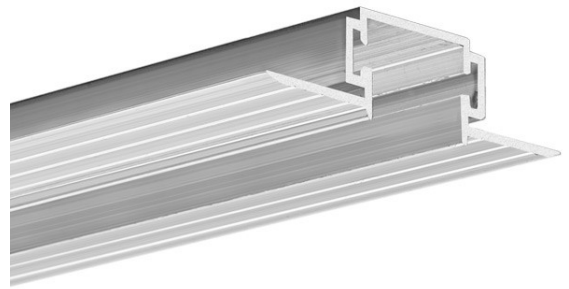

Fill empty fields

Product nr.	
Fixture type	
Company	
Job name	
Date	

TECHNICAL SPECIFICATION

18044NA_2	Non anodized (raw)	2000 mm
18044NA_3	Non anodized (raw)	3000 mm

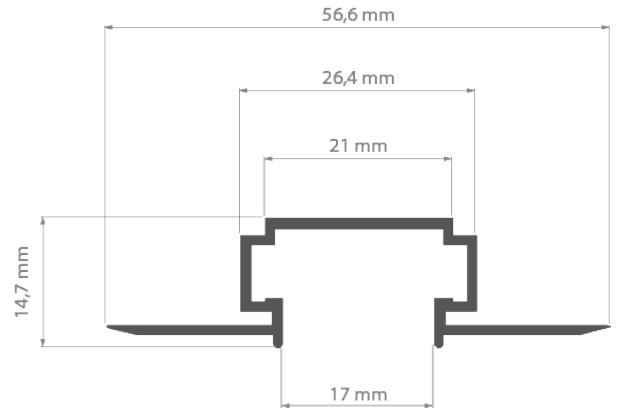

RELATED PROFILES



Ref: C0370ANODA

RELATED PRODUCTS

END CAPS

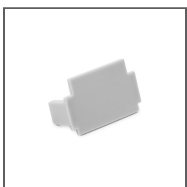

Ref: 24239

ACCESSORIES



Ref: 42717

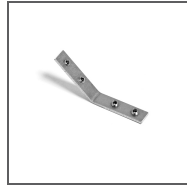

Ref: 42719

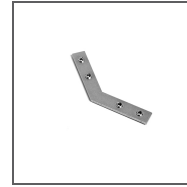

Ref: 42720

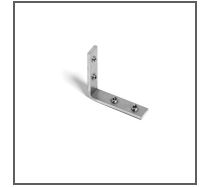

Ref: 42718



Ref: 42716

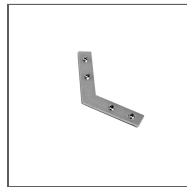

Ref: 42728

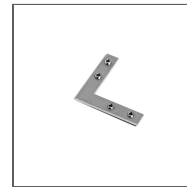

Ref: 42723



Ref: 42729



Ref: 42725

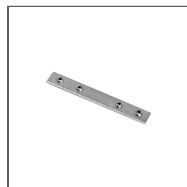

Ref: 42724

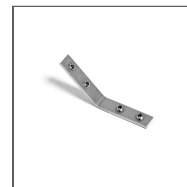

Ref: 42727

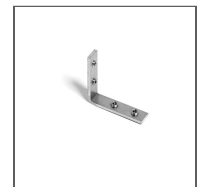

Ref: 42726

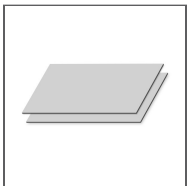

Ref: 70261